

Re. No.	DESCRIPTION	DATE	DS.	CH.	AP.
△					
△					
△					

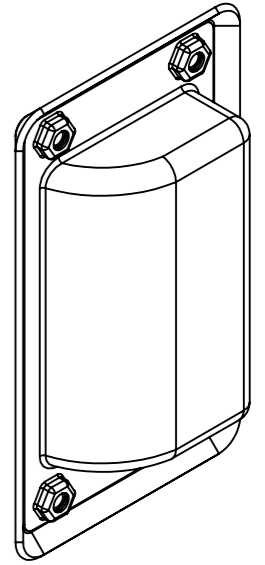

※ PANEL DRILLING MIMENSIONS

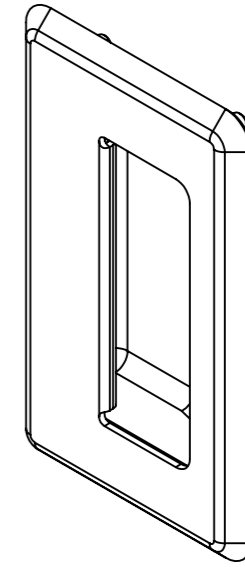
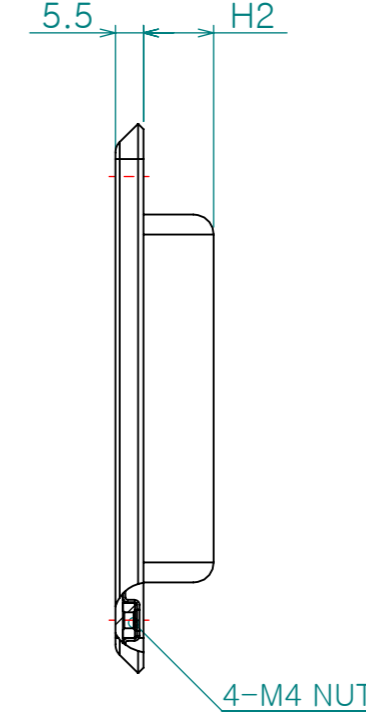
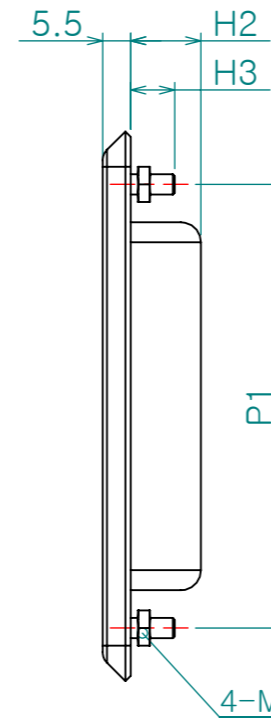
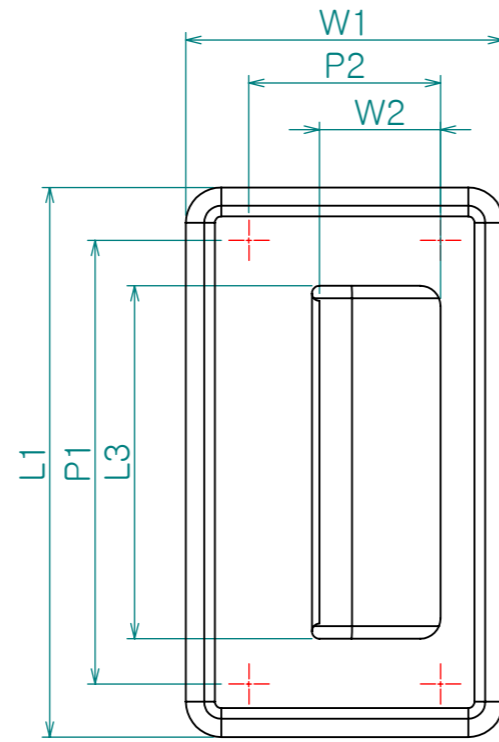
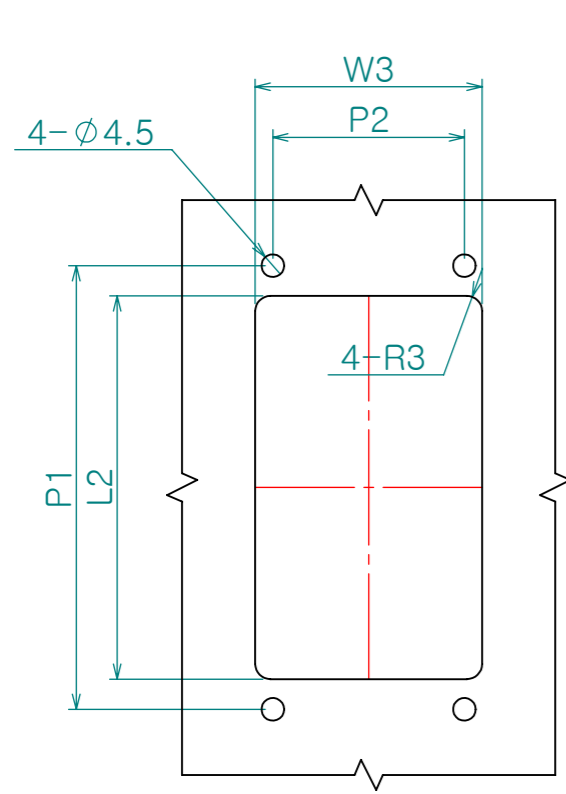
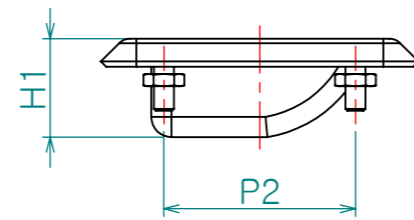

※ BOLT TYPE

※ NUT TYPE

제품명	L1	L2	L3	W1	W2	W3	H1	H2	H3	P1	P2
CA-1011-1	94	63	61	60	25	43	17	12	9	76	32
CA-1011-2	109	76	70	63	24	45	19.5	14	9	88	38
CA-1011-2N									-		
CA-1011-3	137	99	95	86.5	35	64	24	18.5	9	110	65
CA-1011-3N									-		

Note

1. 특징 :

2. 용도 :

※ N - NUT TYPE 임.

Dimension (mm)	Precision	Material	Dwg. No.	QTY
0.5~3	±0.05	SUS304	Part Name.	**
3~6		Finish		**
6~30	±0.1	HAIRLINE	Ass'y Name	-
30~120	±0.15	Revision	**	Scale
120~315	±0.2	-	Model No.	1:1.5
315~1000	±0.3	Date	CA-1011	
1000~2000	±0.5	2013-03-27	Designed by	
KS B 0412에 준함		Checked by	Approved by	